

Vernier calipers ULTRA active inox matt in box
Without points, with fine adjustment
300x90-1/20mm

Product 1876103h

number:

EAN / 4066918073051

GTIN:

Customs 90173000

code:

Delivery Parcel delivery service

method:

Weight: 0.5kg

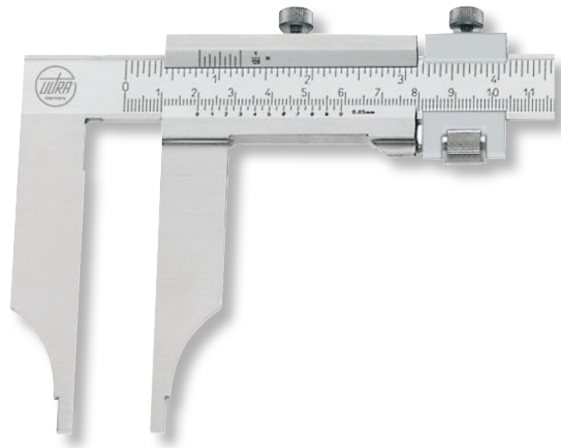

Product description

- DIN 862
- Locking screw
- Hardened stainless steel
- Satin chrome reading parts
- Nibs for inside measurement Ø 10mm

Delivered in a case

Technical Data

Size:	300x90-1/20mm
Article number:	1876103h
Brand:	ULTRA
Fine adjustment:	With
Jaw length:	90mm
Knife points:	Without
Locking screw:	Yes
Material stainless steel:	Hardened
Measuring range:	300mm
Nib for inside meas.:	Ø 10mm
Reading:	1/20mm / 1/128 inch
Reading parts:	Satin chrome plated
Weight:	0.5kg