

Measuring inserts for dial gauges
Special steel with measuring ball
Ø4,5mm

Product number: 1330110-4,5
EAN / GTIN: 4066918046093
Manufacturer number: 62041
Customs code: 90319000
Delivery method: Parcel delivery service
Weight: 0.01kg

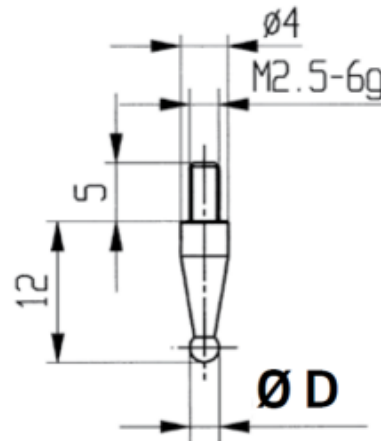

Product description

- For dial gauges and comparator gauges
- Mounting thread M2.5

Delivered in individual packages

Technical Data

Size: Ø4,5mm
Article number: 1330110-4,5
Brand: KÄFER
Manufacturer number: 62041
Diameter: 4,5mm
Weight: 0.01kg