

## Measuring inserts for dial gauges Special steel with thin measuring pin 15mm

**Product number:** 1330106-15  
**EAN / GTIN:** 4066918045782  
**Manufacturer number:** 62083  
**Customs code:** 90319000  
**Delivery method:** Parcel delivery service  
**Weight:** 0.01kg

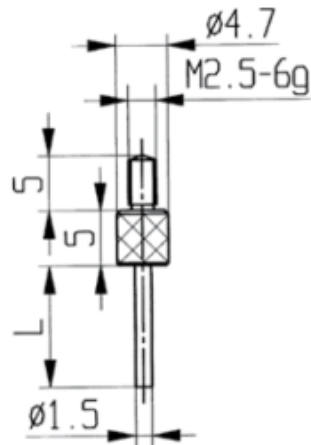

### Product description

- For dial gauges and comparator gauges
- Mounting thread M2.5

Delivered in individual packages

### Technical Data

**Size:** 15mm  
**Article number:** 1330106-15  
**Brand:** KÄFER  
**Manufacturer number:** 62083  
**Length:** 15mm  
**Weight:** 0.01kg