

Measuring inserts for dial gauges with tungsten carbide ball Ø1mm

Product number:	1330210-1
EAN / GTIN:	4066918046840
Manufacturer number:	62060
Customs code:	90319000
Delivery method:	Parcel delivery service
Weight:	0.01kg

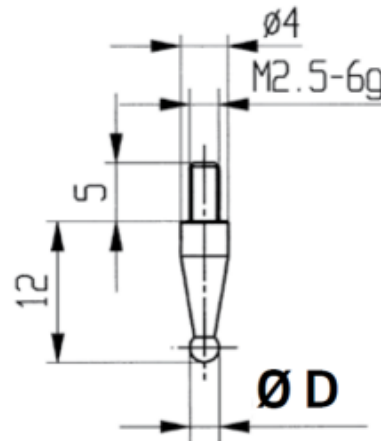

Product description

- For dial gauges and comparator gauges
- Mounting thread M2.5

Delivered in individual packages

Technical Data

Size:	Ø1mm
Article number:	1330210-1
Brand:	KÄFER
Manufacturer number:	62060
Weight:	0.01kg