

Measuring inserts for dial gauges Special steel with thin measuring pin 20mm

Product number: 1330106-20
EAN / GTIN: 4066918045799
Manufacturer number: 62084
Customs code: 90319000
Delivery method: Parcel delivery service
Weight: 0.01kg

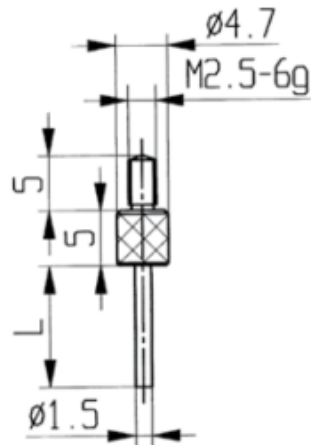

Product description

- For dial gauges and comparator gauges
- Mounting thread M2.5

Delivered in individual packages

Technical Data

Size: 20mm
Article number: 1330106-20
Brand: KÄFER
Manufacturer number: 62084
Length: 20mm
Weight: 0.01kg