

Measuring inserts for dial gauges

Tungsten carbide with ball

Ø4,7mm

Product number:	1330215
EAN / GTIN:	4066918046970
Manufacturer number:	62082
Customs code:	90319000
Delivery method:	Parcel delivery service
Weight:	0.01kg

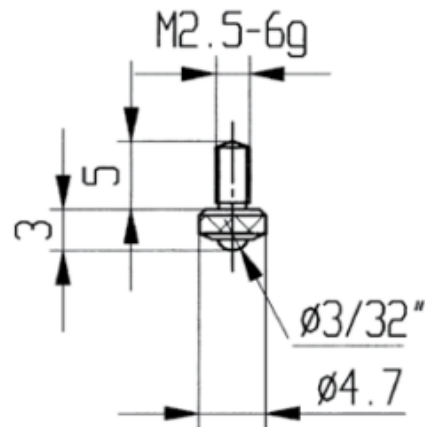

Product description

- For dial gauges and comparator gauges
- Mounting thread M2.5

Delivered in individual packages

Technical Data

Size:	Ø4,7mm
Article number:	1330215
Brand:	KÄFER
Manufacturer number:	62082
Weight:	0.01kg