

## Measuring inserts for dial gauges

### Special steel with ball

### 60mm

<b>Product number:</b>	1330109-60
<b>EAN / GTIN:</b>	4066918045980
<b>Manufacturer number:</b>	62095
<b>Customs code:</b>	90319000
<b>Delivery method:</b>	Parcel delivery service
<b>Weight:</b>	0.01kg

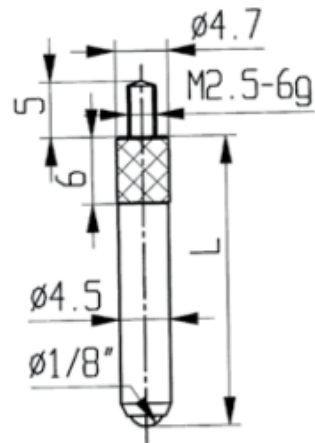

## Product description

- For dial gauges and comparator gauges
- Mounting thread M2.5

Delivered in individual packages

## Technical Data

<b>Size:</b>	60mm
<b>Article number:</b>	1330109-60
<b>Brand:</b>	KÄFER
<b>Manufacturer number:</b>	62095
<b>Length:</b>	60mm
<b>Weight:</b>	0.01kg