

**Jaws with dial gauge mounting hole \varnothing 8mm
for Digital calipers ZEUS CARBON No. 1851 7..
300mm**

Product number: 1851756
EAN / GTIN: 4066918070586
Manufacturer number: 30993 BPC 300mm
Customs code: 90173000
Delivery method: Parcel delivery service
Weight: 0.3kg

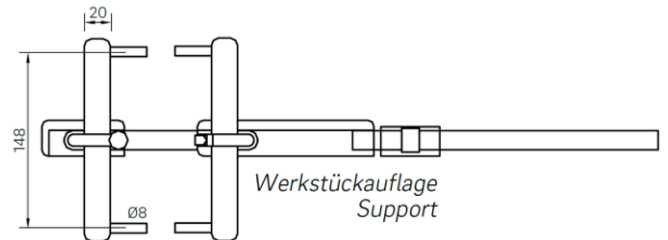

Product description

Delivered in individual packages

Technical Data

Size: 300mm
Article number: 1851756
Brand: DEMM
Manufacturer number: 30993 BPC 300mm
Dial mounting hole: \varnothing 8mm
Length: 300mm
Type: Jaw
Weight: 0.3kg