

Measuring arms (pair)
for BOWERS universal comparative meas. instruments TGU
75mm / Ø 3,5mm

Product number: 1398254
EAN / GTIN: 5051102011918
Manufacturer number: TGUA007
Customs code: 90178090
Delivery method: Parcel delivery service
Weight: 0.8kg

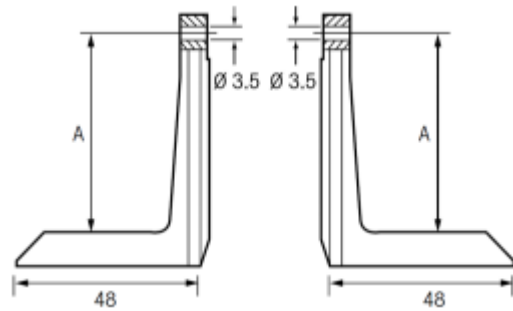

Product description

- Hardened special steel

Delivered in a package (pair)

! Other probe types, thread inserts and special executions on [request](#).

Technical Data

Size: 75mm / Ø 3,5mm
Article number: 1398254
Brand: BOWERS
Manufacturer number: TGUA007
Clamping shaft: Ø 3,5mm
Dimension: 75mm
Material: Hardened steel
Type: Measuring arms
Weight: 0.8kg