

**Measuring inserts for dial gauges**  
**Special steel with measuring ball**  
**Ø3,5mm**

**Product number:** 1330110-3,5  
**EAN / GTIN:** 4066918046079  
**Manufacturer number:** 62039  
**Customs code:** 90319000  
**Delivery method:** Parcel delivery service  
**Weight:** 0.01kg

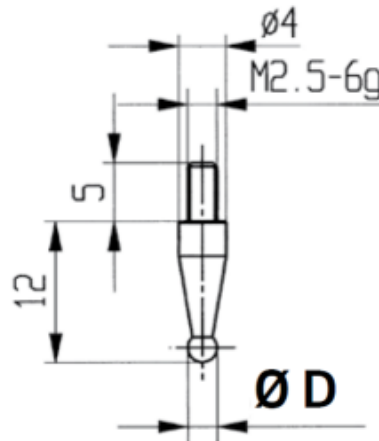

**Product description**

- For dial gauges and comparator gauges
- Mounting thread M2.5

**Delivered in individual packages**

**Technical Data**

**Size:** Ø3,5mm  
**Article number:** 1330110-3,5  
**Brand:** KÄFER  
**Manufacturer number:** 62039  
**Diameter:** 3,5mm  
**Weight:** 0.01kg