

Measuring inserts for dial gauges with tungsten carbide ball Ø6mm

Product number:	1330210-6
EAN / GTIN:	4066918046949
Manufacturer number:	62065
Customs code:	90319000
Delivery method:	Parcel delivery service
Weight:	0.01kg

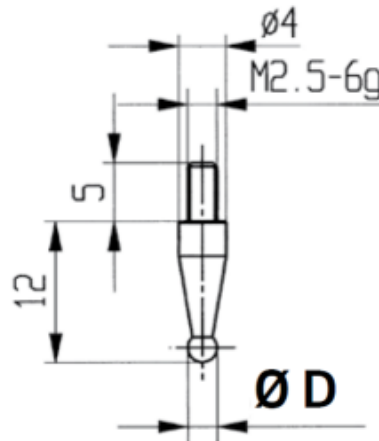

Product description

- For dial gauges and comparator gauges
- Mounting thread M2.5

Delivered in individual packages

Technical Data

Size:	Ø6mm
Article number:	1330210-6
Brand:	KÄFER
Manufacturer number:	62065
Weight:	0.01kg