

Measuring inserts for dial gauges with tungsten carbide ball Ø5,5mm

Product number:	1330210-5,5
EAN / GTIN:	4066918046932
Manufacturer number:	62070
Customs code:	90319000
Delivery method:	Parcel delivery service
Weight:	0.01kg

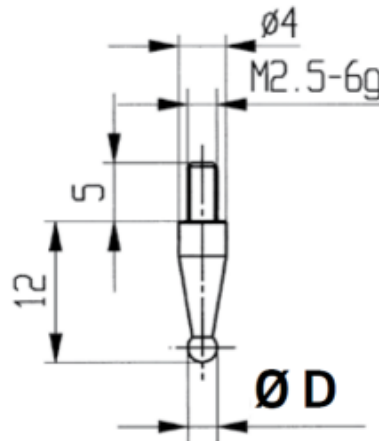

Product description

- For dial gauges and comparator gauges
- Mounting thread M2.5

Delivered in individual packages

Technical Data

Size:	Ø5,5mm
Article number:	1330210- 5,5
Brand:	KÄFER
Manufacturer number:	62070
Weight:	0.01kg