

**Measuring inserts for dial gauges  
with tungsten carbide ball  
Ø 0,8mm**

**Product number:** 1330218-0,8  
**EAN / GTIN:** 4066918107121  
**Manufacturer number:** 62411  
**Customs code:** 90319000  
**Delivery method:** Parcel delivery service  
**Weight:** 0.01kg

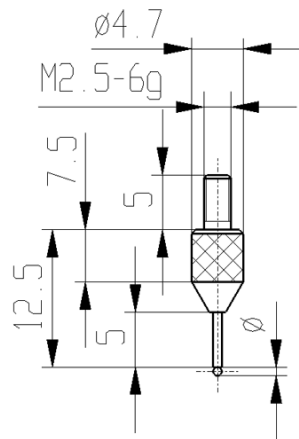

**Product description**

- For dial gauges and comparator gauges
- Mounting thread M2.5

**Delivered in individual packages**

**Technical Data**

**Size:** Ø 0,8mm  
**Article number:** 1330218-0,8  
**Brand:** KÄFER  
**Manufacturer number:** 62411  
**Dimension:** Ø 0,8mm  
**Execution:** With ball  
**Weight:** 0.01kg