

**Concentricity testers SIMMY LDS-R
with rollers, Accuracy 0,002mm
Ø10-100/370/500x118x140mm**

Product number: 1559524
EAN / GTIN: 4066918059925
Manufacturer number: 00642
Customs code: 90318080
Delivery method: Parcel delivery service
Weight: 9.5kg

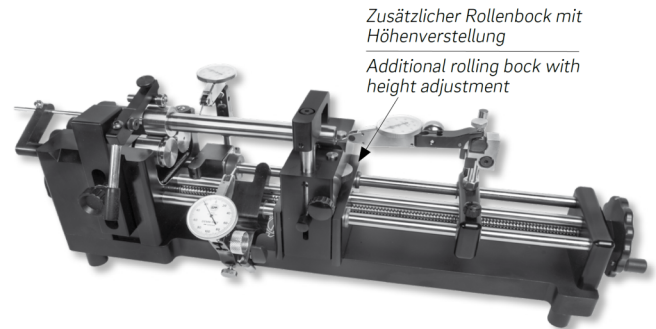

Product description

- Works standard
- For checking concentricity and wobble
- Concentricity accuracy 0.002mm
- Precision rollers Ø30mm with groove made of hardened tool steel
- Drive with hand wheel on side face
- Aluminium housing, anodized
- Hard chromed steel bars for measuring stand sliding
- Spring loaded work piece clamping system
- Work piece anvil adjustable in length and height
- 2 measuring stands for dial test indicators, mounting hole Ø 8mm

1559 511 - 1559 516: Additional rolling block, without height adjustment

1559 521 - 1559 526: Additional rolling block, with height adjustment

Delivered in individual packages without dial test indicators

Technical Data

Size:	Ø10-100/370/500x118x140mm
Article number:	1559524
Brand:	DEMM
Manufacturer number:	00642
Dimension:	500x118x140mm
Height adjustment:	Without
Workpiece Ø:	10-100mm
Weight:	9.5kg