

**Measuring inserts for dial gauges
with tungsten carbide pin
Ø 0,4mm**

Product number: 1330217-0,4
EAN / GTIN: 4066918107060
Manufacturer number: 62405
Customs code: 90319000
Delivery method: Parcel delivery service
Weight: 0.01kg

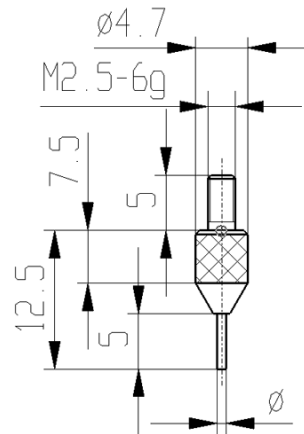

Product description

- For dial gauges and comparator gauges
- Mounting thread M2.5

Delivered in individual packages

Technical Data

Size: Ø 0,4mm
Article number: 1330217-0,4
Brand: KÄFER
Manufacturer number: 62405
Dimension: Ø 0,4mm
Execution: With pin
Weight: 0.01kg