

Measuring arms (pair)
for BOWERS universal comparative meas. instruments TGU
50mm / Ø 3,5mm

Product number: 1398253
EAN / GTIN: 5051102057558
Manufacturer number: TGUA006
Customs code: 90178090
Delivery method: Parcel delivery service
Weight: 0.1kg

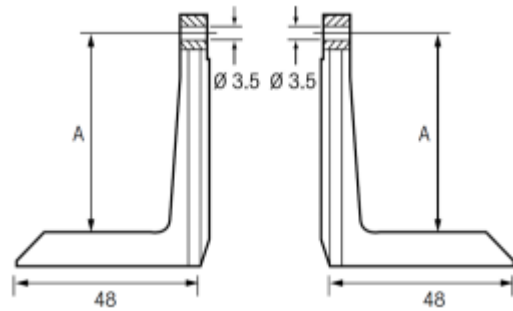

Product description

- Hardened special steel

Delivered in a package (pair)

! Other probe types, thread inserts and special executions on [request](#).

Technical Data

Size: 50mm / Ø 3,5mm
Article number: 1398253
Brand: BOWERS
Manufacturer number: TGUA006
Clamping shaft: Ø 3,5mm
Dimension: 50mm
Material: Hardened steel
Type: Measuring arms
Weight: 0.1kg