

Measuring inserts for dial gauges

Special steel with ball

6mm

Product number:	1330101
EAN / GTIN:	4066918045584
Manufacturer number:	22201
Customs code:	90319000
Delivery method:	Parcel delivery service
Weight:	0.01kg

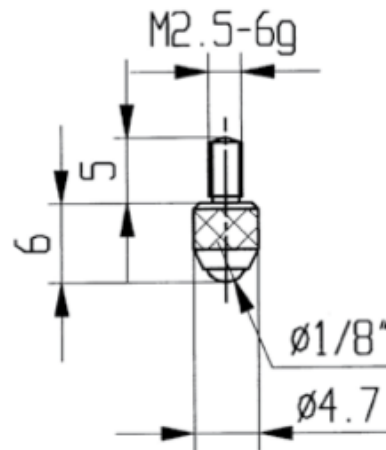

Product description

- For dial gauges and comparator gauges
- Mounting thread M2.5

Delivered in individual packages

Technical Data

Size:	6mm
Article number:	1330101
Brand:	KÄFER
Manufacturer number:	22201
Length:	6mm
Weight:	0.01kg