

Precision vises, threaded spindle

Acc. 0,005mm/100mm

60x48mm

Product number: 1586101

EAN / GTIN: 4066918060747

Customs code: 84662098

Delivery method: Parcel delivery service

Weight: 1.5kg

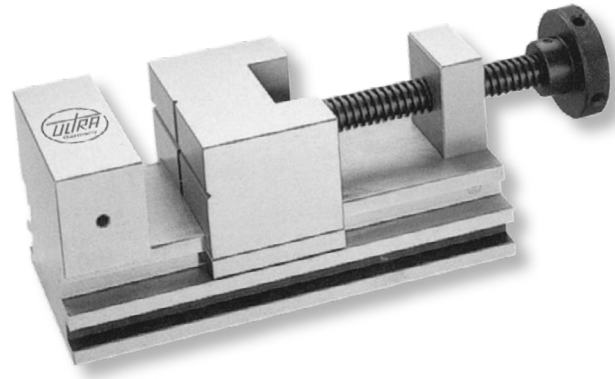

Product description

- Works standard
- Accuracy 0.005mm / 100mm
- Hardened and ground special steel
- 4-side workpiece machining

Delivered in individual packages

Technical Data

Size: 60x48mm

Article number: 1586101

Brand: ULTRA

B: 48mm

H1: 25mm

H2: 54mm

L: 155mm

M: 60mm

Weight: 1.5kg