

Measuring inserts for dial gauges Special steel with measuring ball Ø5mm

Product number:	1330110-5
EAN / GTIN:	4066918046109
Manufacturer number:	62042
Customs code:	90319000
Delivery method:	Parcel delivery service
Weight:	0.01kg

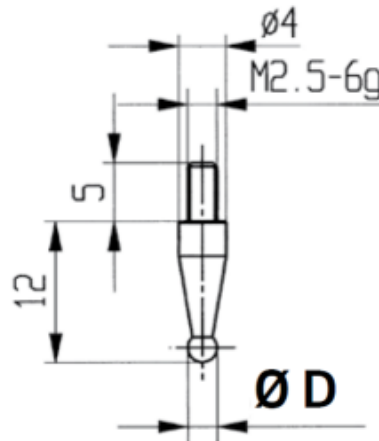

Product description

- For dial gauges and comparator gauges
- Mounting thread M2.5

Delivered in individual packages

Technical Data

Size:	Ø5mm
Article number:	1330110-5
Brand:	KÄFER
Manufacturer number:	62042
Diameter:	5mm
Weight:	0.01kg