

**Digital calipers ARGO BD CARBON in box**  
**With cylindrical measuring pins, without fine adjustment**  
**2000x150/0,01mm IP67**

<b>Product number:</b>	1851965ip
<b>EAN / GTIN:</b>	4066918071118
<b>Manufacturer number:</b>	00569
<b>Customs code:</b>	90173000
<b>Delivery method:</b>	Truck freight
<b>Weight:</b>	2.65kg

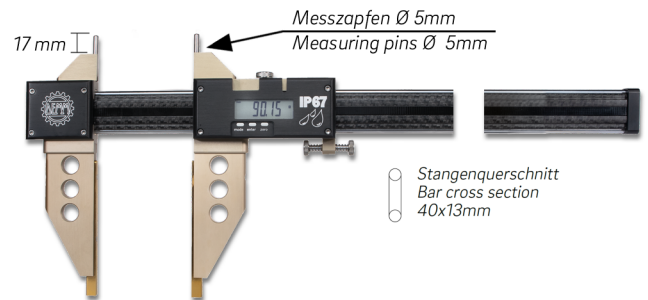

## Product description

- Works standard
- Protection class IP67, Sylvac System
- Locking screw
- With constant measuring force due spring
- Carbon profile with high strength of shape 40x13mm
- Guiding elements made of chromed steel
- Measuring faces made of stainless steel, TIN coated
- Extremely low weight
- Large LCD display

### Delivered in a case

#### Functions:

- On/Off
- Auto-On by sliding
- mm/inch commutation
- Zero setting at any position
- ABS function (fixed 0 point)
- Absolute system
- Preset function ±
- Hold function
- Data output Proximity

## Technical Data

<b>Size:</b>	2000x150/0,01mm IP67
<b>Article number:</b>	1851965ip
<b>Brand:</b>	DEMM
<b>Manufacturer number:</b>	00569
<b>Accuracy:</b>	0,06mm
<b>Bar:</b>	Carbon
<b>Bar cross section:</b>	40x13mm
<b>Cyl. meas. pins Ø5mm:</b>	With
<b>Data output:</b>	Proximity
<b>Fine adjustment:</b>	Without
<b>Guiding elements:</b>	Chrome steel
<b>Jaw length:</b>	150mm
<b>Measuring faces:</b>	Stainless steel TIN
<b>Measuring range:</b>	2000mm / 80 inch
<b>Protection class:</b>	IP67
<b>Reading:</b>	0,01mm / .0005 inch
<b>Weight:</b>	2.65kg