

Probes with pin (pair)
for DEMM universal comparative measuring instruments
Ø 3,5x12 / Ø 8x105mm

Product number: 1390318
EAN / GTIN: 4066918051837
Manufacturer number: 99904
Customs code: 90179000
Delivery method: Parcel delivery service
Weight: 0.06kg

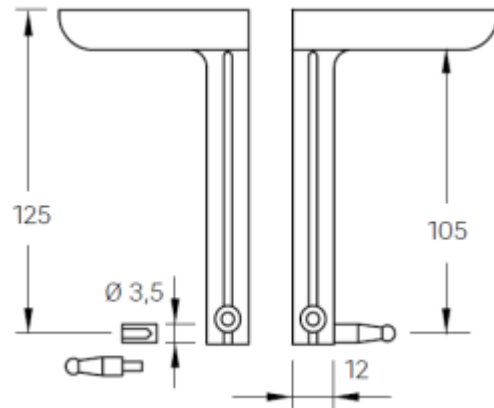

Product description

- Hardened special steel
- Suitable for CIRCE No. 1851 8.. with and without ip, PEGASO P No. 1851 9.., PLATON No. 1399 1.. / 1399 2.. / 1398 5.. / 1398 6.. and GEA No. 1399 6..

Delivered in a package (pair)

! Other probe types and special executions on [request](#).

Technical Data

Size: Ø 3,5x12 / Ø 8x105mm
Article number: 1390318
Brand: DEMM
Manufacturer number: 99904
Clamping shaft: Ø 8mm
Dimension: Ø 3,5x12 / Ø 8x105mm
Material: Hardened steel
Type: With pin
Weight: 0.06kg