

Measuring inserts for dial gauges

Special steel with bore

Ø8,4mm

Product number:	1330602
EAN / GTIN:	4066918047328
Manufacturer number:	62075
Customs code:	90319000
Delivery method:	Parcel delivery service
Weight:	0.01kg

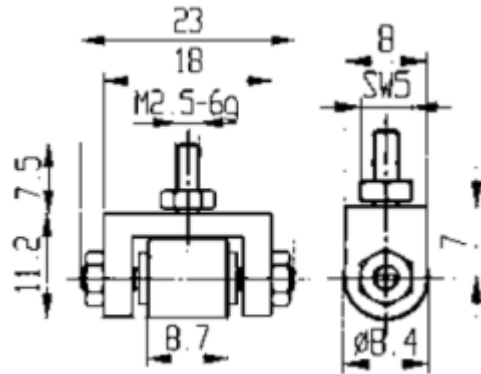

Product description

- For dial gauges and comparator gauges
- Mounting thread M2.5

Delivered in individual packages

Technical Data

Size:	Ø8,4mm
Article number:	1330602
Brand:	KÄFER
Manufacturer number:	62075
Weight:	0.01kg