

Digital calipers ARGO BD CARBON in box
With cylindrical measuring pins, without fine adjustment
1000x150/0,01mm IP67

Product number:	1851961ip
EAN / GTIN:	4066918071071
Manufacturer number:	00565
Customs code:	90173000
Delivery method:	Parcel delivery service
Weight:	1.9kg

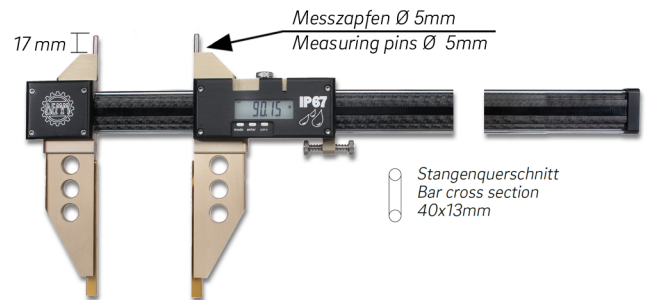

Product description

- Works standard
- Protection class IP67, Sylvac System
- Locking screw
- With constant measuring force due spring
- Carbon profile with high strength of shape 40x13mm
- Guiding elements made of chromed steel
- Measuring faces made of stainless steel, TIN coated
- Extremely low weight
- Large LCD display

Delivered in a case

Functions:

- On/Off
- Auto-On by sliding
- mm/inch commutation
- Zero setting at any position
- ABS function (fixed 0 point)
- Absolute system
- Preset function ±
- Hold function
- Data output Proximity

Technical Data

Size:	1000x150/0,01mm IP67
Article number:	1851961ip
Brand:	DEMM
Manufacturer number:	00565
Accuracy:	0,04mm
Bar:	Carbon
Bar cross section:	40x13mm
Cyl. meas. pins Ø5mm:	With
Data output:	Proximity
Fine adjustment:	Without
Guiding elements:	Chrome steel
Jaw length:	150mm
Measuring faces:	Stainless steel TIN
Measuring range:	1000mm / 40 inch
Protection class:	IP67
Reading:	0,01mm / .0005 inch
Weight:	1.9kg