

**Precision vises, threaded spindle
sine function Acc. 0,005mm/100mm
70x63mm/ 0-45°**

Product number: 1587101

EAN / GTIN: 4066918060822

Customs code: 84662098

Delivery method: Parcel delivery service

Weight: 5kg

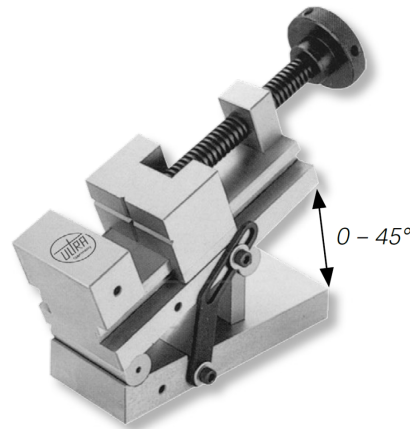

Product description

- Works standard
- Accuracy 0.005mm / 100mm
- Hardened and ground special steel

Delivered in individual packages

Technical Data

Size: 70x63mm/ 0-45°

Article number: 1587101

Brand: ULTRA

B: 63mm

Execution: Tilting

H1: 30mm

H2: 96mm

L: 175mm

M: 70mm

Weight: 5kg