

**Measuring inserts for dial gauges
with tungsten carbide pin
Ø 0,2mm**

Product number: 1330217-0,2
EAN / GTIN: 4066918107053
Manufacturer number: 62404
Customs code: 90319000
Delivery method: Parcel delivery service
Weight: 0.01kg

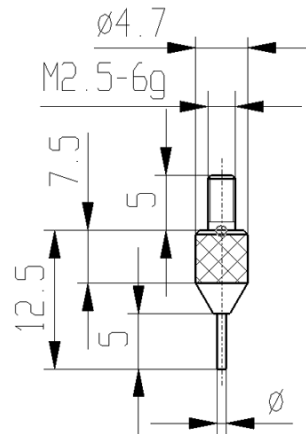

Product description

- For dial gauges and comparator gauges
- Mounting thread M2.5

Delivered in individual packages

Technical Data

Size: $\varnothing 0,2\text{mm}$
Article number: 1330217-0,2
Brand: KÄFER
Manufacturer number: 62404
Dimension: $\varnothing 0,2\text{mm}$
Execution: With pin
Weight: 0.01kg