

Measuring inserts for dial gauges Special steel with measuring ball

Product number: 1330611
EAN / GTIN: 4066918047335
Manufacturer number: 62142
Customs code: 90319000
Delivery method: Parcel delivery service
Weight: 0.01kg

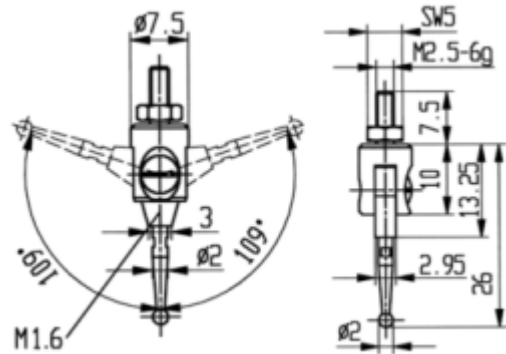

Product description

- For dial gauges and comparator gauges
- Mounting thread M2.5

Delivered in individual packages

Technical Data

Size:

Article number: 1330611
Brand: KÄFER
Manufacturer number: 62142
Weight: 0.01kg