

Measuring inserts for dial gauges Special steel with thin measuring pin 15mm

Product number: 1330106-15
EAN / GTIN: 4066918045782
Manufacturer number: 62083
Customs code: 90319000
Delivery method: Parcel delivery service
Weight: 0.01kg

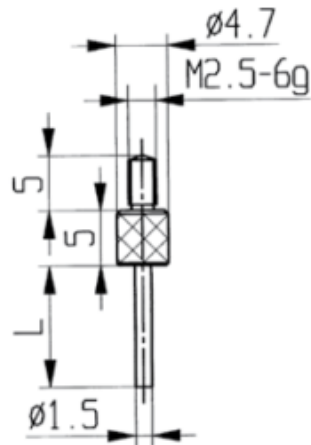

Product description

- For dial gauges and comparator gauges
- Mounting thread M2.5

Delivered in individual packages

Technical Data

Size: 15mm
Article number: 1330106-15
Brand: KÄFER
Manufacturer number: 62083
Length: 15mm
Weight: 0.01kg