

Measuring inserts for dial gauges with tungsten carbide ball Ø 0,6mm

Product number:	1330218-0,6
EAN / GTIN:	4066918107114
Manufacturer number:	62410
Customs code:	90319000
Delivery method:	Parcel delivery service
Weight:	0.01kg

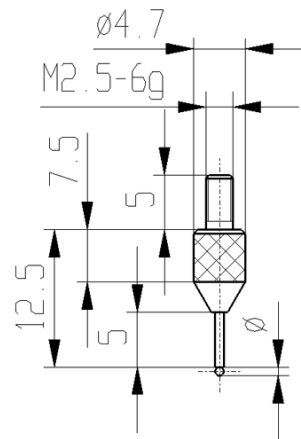

Product description

- For dial gauges and comparator gauges
- Mounting thread M2.5

Delivered in individual packages

Technical Data

Size:	Ø 0,6mm
Article number:	1330218- 0,6
Brand:	KÄFER
Manufacturer number:	62410
Dimension:	Ø 0,6mm
Execution:	With ball
Weight:	0.01kg