

Digital calipers ARGO BD CARBON in box
With cylindrical measuring pins, without fine adjustment
2000x200/0,01mm IP67

Product number:	1851966ip
EAN / GTIN:	4066918071125
Manufacturer number:	00577
Customs code:	90173000
Delivery method:	Truck freight
Weight:	2.78kg

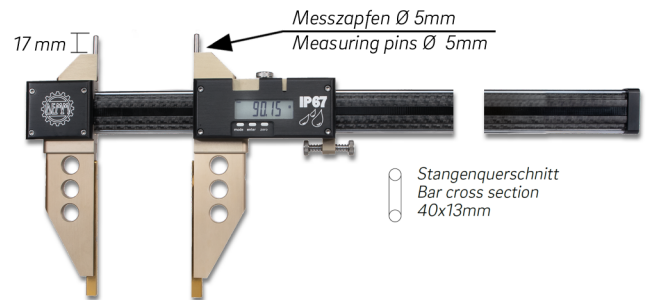

Product description

- Works standard
- Protection class IP67, Sylvac System
- Locking screw
- With constant measuring force due spring
- Carbon profile with high strength of shape 40x13mm
- Guiding elements made of chromed steel
- Measuring faces made of stainless steel, TIN coated
- Extremely low weight
- Large LCD display

Delivered in a case

Functions:

- On/Off
- Auto-On by sliding
- mm/inch commutation
- Zero setting at any position
- ABS function (fixed 0 point)
- Absolute system
- Preset function \pm
- Hold function
- Data output Proximity

Technical Data

Size:	2000x200/0,01mm IP67
Article number:	1851966ip
Brand:	DEMM
Manufacturer number:	00577
Accuracy:	0,06mm
Bar:	Carbon
Bar cross section:	40x13mm
Cyl. meas. pins Ø5mm:	With
Data output:	Proximity
Fine adjustment:	Without
Guiding elements:	Chrome steel
Jaw length:	200mm
Measuring faces:	Stainless steel TIN
Measuring range:	2000mm / 80 inch
Protection class:	IP67
Reading:	0,01mm / .0005 inch
Weight:	2.78kg