

Measuring inserts for dial gauges Sapphire insert with ball

Product number: 1330409
EAN / GTIN: 4066918047274
Manufacturer number: 62022
Customs code: 90319000
Delivery method: Parcel delivery service
Weight: 0.01kg

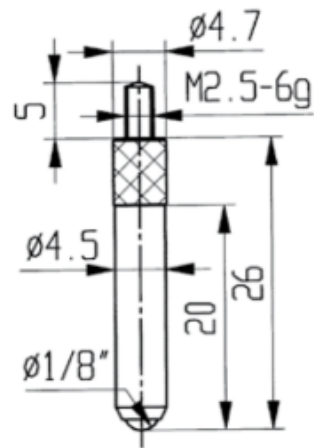

Product description

- For dial gauges and comparator gauges
- Mounting thread M2.5

Delivered in individual packages

Technical Data

Size:

Article number: 1330409

Brand: KÄFER

Manufacturer number: 62022

Weight: 0.01kg