

Measuring inserts for dial gauges

Special steel with ball

60mm

Product number:	1330109-60
EAN / GTIN:	4066918045980
Manufacturer number:	62095
Customs code:	90319000
Delivery method:	Parcel delivery service
Weight:	0.01kg

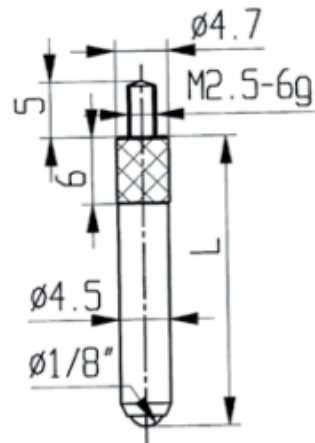

Product description

- For dial gauges and comparator gauges
- Mounting thread M2.5

Delivered in individual packages

Technical Data

Size:	60mm
Article number:	1330109-60
Brand:	KÄFER
Manufacturer number:	62095
Length:	60mm
Weight:	0.01kg