

Measuring inserts for dial gauges with tungsten carbide ball Ø4,5mm

Product number:	1330210-4,5
EAN / GTIN:	4066918046918
Manufacturer number:	62069
Customs code:	90319000
Delivery method:	Parcel delivery service
Weight:	0.01kg

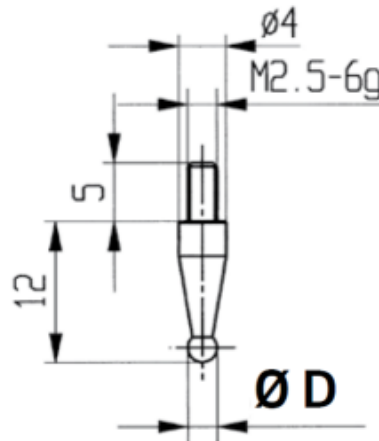

Product description

- For dial gauges and comparator gauges
- Mounting thread M2.5

Delivered in individual packages

Technical Data

Size:	Ø4,5mm
Article number:	1330210- 4,5
Brand:	KÄFER
Manufacturer number:	62069
Weight:	0.01kg