

**Concentricity testers SIMMY LDS-R
with rollers, Accuracy 0,002mm
Ø1,5-50/570/700x118x140mm**

Product number:	1559525
EAN / GTIN:	4066918059932
Manufacturer number:	00883
Customs code:	90318080
Delivery method:	Parcel delivery service
Weight:	10.8kg

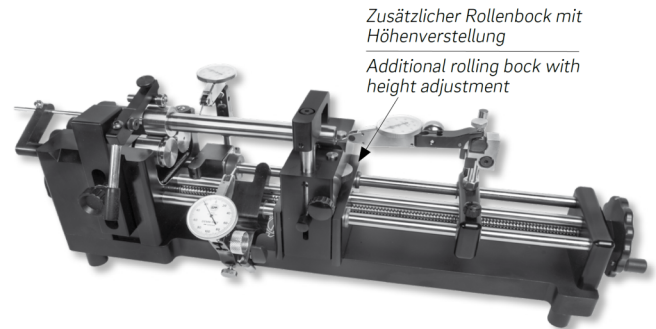

Product description

- Works standard
- For checking concentricity and wobble
- Concentricity accuracy 0.002mm
- Precision rollers Ø30mm with groove made of hardened tool steel
- Drive with hand wheel on side face
- Aluminium housing, anodized
- Hard chromed steel bars for measuring stand sliding
- Spring loaded work piece clamping system
- Work piece anvil adjustable in length and height
- 2 measuring stands for dial test indicators, mounting hole Ø 8mm

1559 511 - 1559 516: Additional rolling block, without height adjustment

1559 521 - 1559 526: Additional rolling block, with height adjustment

Delivered in individual packages without dial test indicators

Technical Data

Size:	Ø1,5-50/570/700x118x140mm
Article number:	1559525
Brand:	DEMM
Manufacturer number:	00883
Dimension:	700x118x140mm
Height adjustment:	Without
Workpiece Ø:	1,5-50mm
Weight:	10.8kg