

Measuring inserts for dial gauges

Tungsten carbide with ball

Ø4,7mm

Product number:	1330201
EAN / GTIN:	4066918046765
Manufacturer number:	62001
Customs code:	90319000
Delivery method:	Parcel delivery service
Weight:	0.01kg

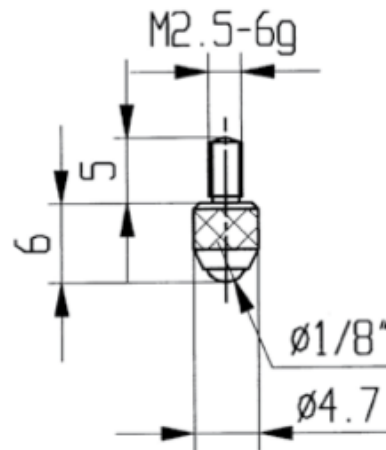

Product description

- For dial gauges and comparator gauges
- Mounting thread M2.5

Delivered in individual packages

Technical Data

Size:	Ø4,7mm
Article number:	1330201
Brand:	KÄFER
Manufacturer number:	62001
Weight:	0.01kg