

**Vernier calipers ULTRA active inox matt in box**  
**With points, with fine adjustment**  
**300x90-1/20mm**

**Product number:** 1877103h

**EAN / GTIN:** 4066918073075

**Customs code:** 90173000

**Delivery method:** Parcel delivery service

**Weight:** 0.5kg

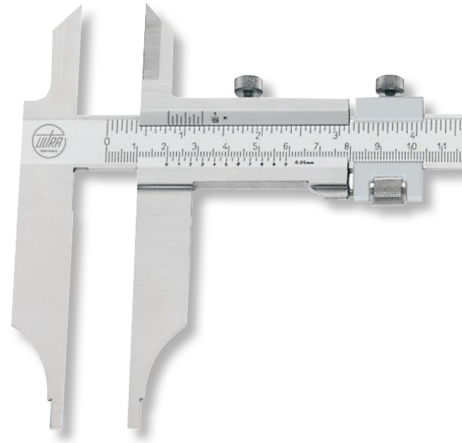

## Product description

- DIN 862
- Locking screw
- Hardened stainless steel
- Satin chrome reading parts
- Nibs for inside measurement Ø 10mm

**Delivered in a case**

## Technical Data

<b>Size:</b>	300x90-1/20mm
<b>Article number:</b>	1877103h
<b>Brand:</b>	ULTRA
<b>Fine adjustment:</b>	With
<b>Jaw length:</b>	90mm
<b>Knife points:</b>	With
<b>Locking screw:</b>	Yes
<b>Material stainless steel:</b>	Hardened
<b>Measuring range:</b>	300mm
<b>Nib for inside meas.:</b>	Ø 10mm
<b>Reading:</b>	1/20mm / 1/128 inch
<b>Reading parts:</b>	Satin chrome plated
<b>Weight:</b>	0.5kg