

Marking vernier calipers, hardened special steel, matt
With scaled scribing bar, with fine adjustment
300x160-1/20mm

Product number: 1912103
EAN / GTIN: 4066918074294
Customs code: 90172039
Delivery method: Parcel delivery service
Weight: 0.48kg

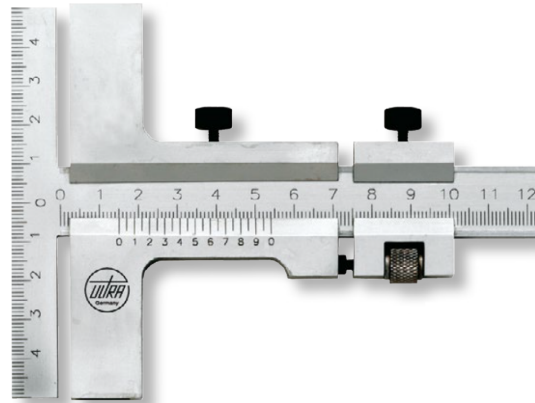

Product description

- Works standard
- Fine adjustment and clamping screw
- Hardened special steel
- Satin chrome reading parts

Delivered in individual packages

Technical Data

Size: 300x160-1/20mm
Article number: 1912103
Brand: ULTRA
Locking screw: Yes
Material special steel: Hardened
Measuring range: 300mm
Reading: 1/20mm
Reading parts: Satin chrome plated
Scribing bar: 160mm
Weight: 0.48kg