

**Measuring bridges ULTRA active stainless steel hardened
for calipers No. 6852 1.., 6852 11., 6852 12., 6852 13.**

500mm

Product number: 6852192

EAN / GTIN: 4066918103024

Customs code: 90173000

Delivery method: Parcel delivery service

Weight: 0.9kg

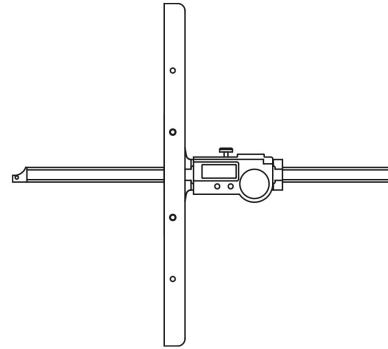

Product description

Delivered in individual packages

Technical Data

Size:	500mm
Article number:	6852192
Brand:	ULTRA
Bridge length:	500mm
Material stainless steel:	Hardened
Weight:	0.9kg