

Precision vises, threaded spindle

Acc. 0,005mm/100mm

95x73mm

Product number: 1586103

EAN / GTIN: 4066918060761

Customs code: 84662098

Delivery method: Parcel delivery service

Weight: 4.3kg

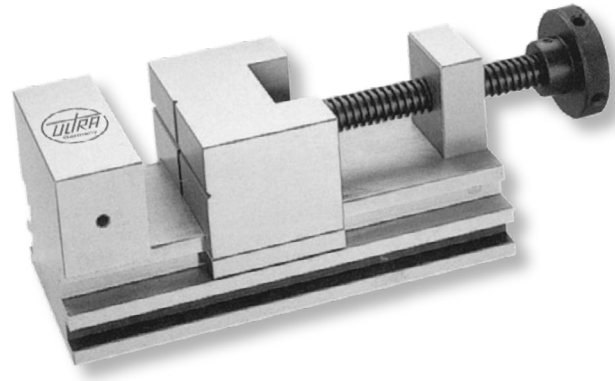

Product description

- Works standard
- Accuracy 0.005mm / 100mm
- Hardened and ground special steel
- 4-side workpiece machining

Delivered in individual packages

Technical Data

Size: 95x73mm

Article number: 1586103

Brand: ULTRA

B: 73mm

H1: 32mm

H2: 65mm

L: 175mm

M: 95mm

Weight: 4.3kg