

**Vernier depth calipers ULTRA active inox  
with offset measuring faces, with bevelled point  
200x100-1/20mm**

**Product number:** 1948101

**EAN / GTIN:** 4066918074980

**Customs code:** 90173000

**Delivery method:** Parcel delivery service

**Weight:** 0.13kg

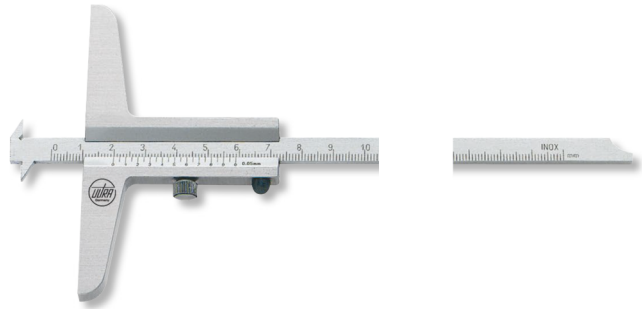

## Product description

- DIN 862
- Locking screw
- Hardened stainless steel
- Satin chrome reading parts
- mm-graduation on both sides
- Reversible measuring rod

**Delivered in individual packages**

**! Other measuring ranges and versions on [request](#).**

## Technical Data

<b>Size:</b>	200x100-1/20mm
<b>Article number:</b>	1948101
<b>Brand:</b>	ULTRA
<b>Bridge length:</b>	100mm
<b>Locking screw:</b>	Yes
<b>Material stainless steel:</b>	Hardened
<b>Measuring range:</b>	200mm
<b>Reading:</b>	1/20mm
<b>Reading parts:</b>	Satin chrome plated
<b>Type:</b>	Offset meas. faces
<b>Weight:</b>	0.13kg