

**Jaws with dial gauge mounting hole Ø 8mm
for Digital calipers ZEUS CARBON No. 1851 7..
150mm**

Product number: 1851754
EAN / GTIN: 4066918070562
Manufacturer number: 30993 BPC 150mm
Customs code: 90173000
Delivery method: Parcel delivery service
Weight: 0.3kg

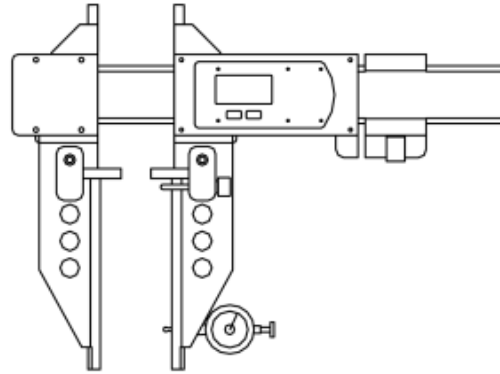

*Schnabel mit Messuhraufnahme Ø 8mm
Jaw with dial gauge hole Ø 8mm*

Product description

Delivered in individual packages

Technical Data

Size: 150mm
Article number: 1851754
Brand: DEMM
Manufacturer number: 30993 BPC 150mm
Dial mounting hole: Ø 8mm
Length: 150mm
Type: Jaw
Weight: 0.3kg