

Measuring inserts for dial gauges Ruby insert with ball

Product number: 1330309
EAN / GTIN: 4066918047205
Manufacturer number: 62021
Customs code: 90319000
Delivery method: Parcel delivery service
Weight: 0.01kg

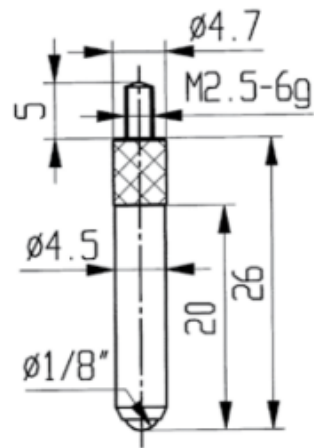

Product description

- For dial gauges and comparator gauges
- Mounting thread M2.5

Delivered in individual packages

Technical Data

Size:

Article number: 1330309

Brand: KÄFER

Manufacturer number: 62021

Weight: 0.01kg